

SECC. A-A'

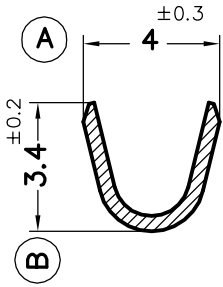

SECC. B-B'

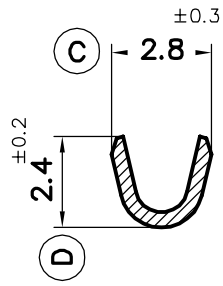

SECC. C-C'

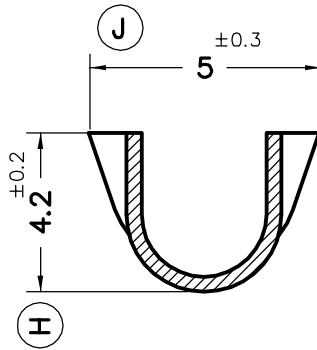

FORMA DE SUMINISTRO

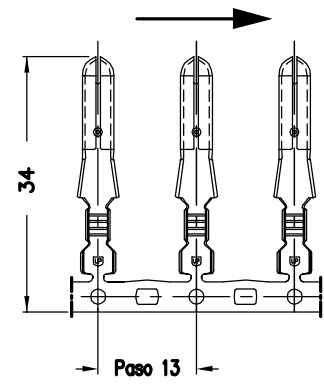

E 1:1

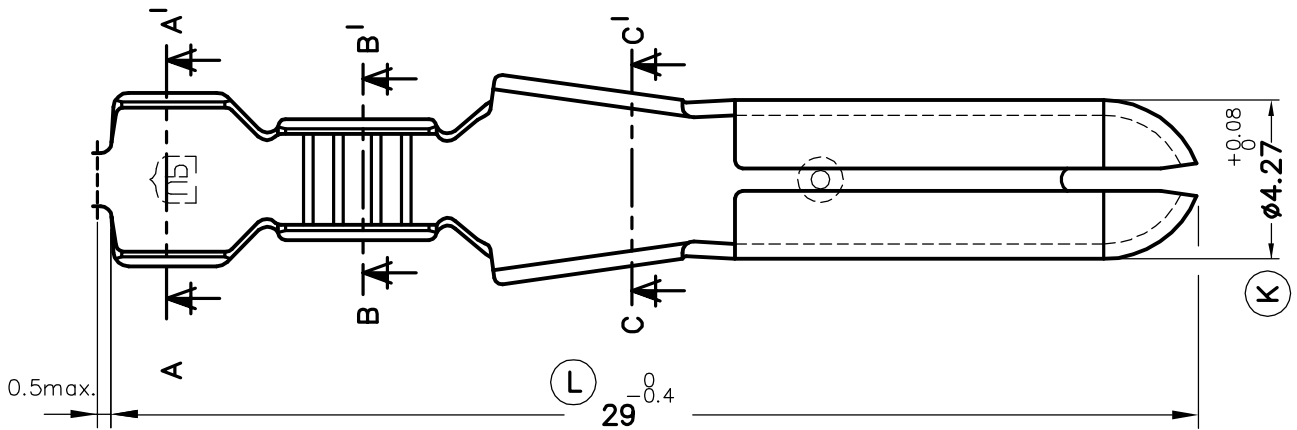
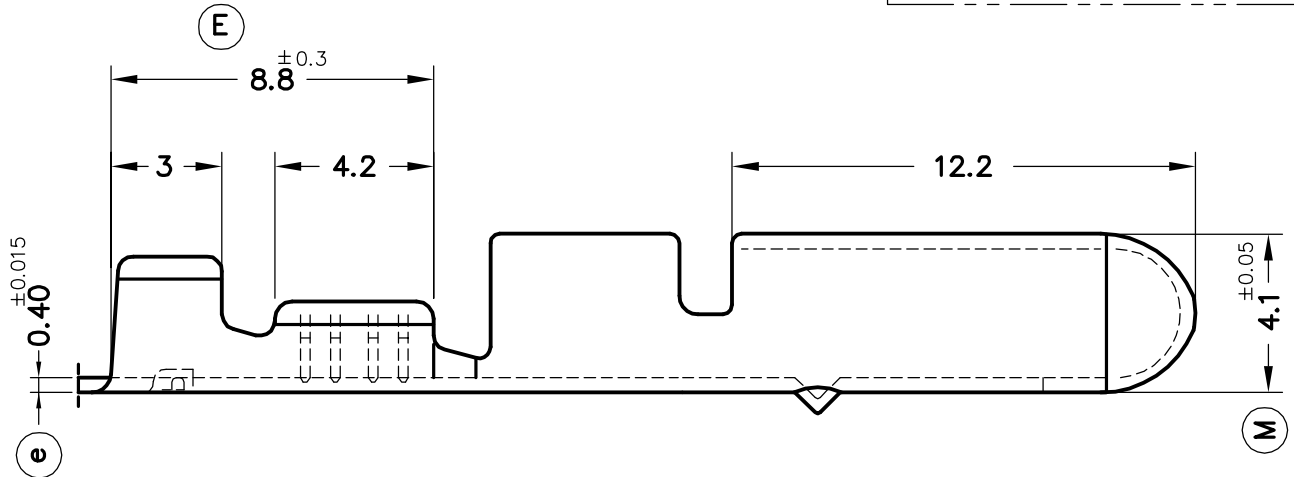

7532.70	Natural	CuNi18Zn20	0.3±0.6mm. ²	2.2mm. Máx.					00	1a. Edición	17/03/10
Referencias	Acabados	Material	Sección Conductor	φ Aislante	A	B	C	D	Rev.	Modificación	Fecha



ESCUBEDO
Especialitats Elèctriques Escubedo S.A.

TERMINAL MACHO CILINDRICO - TBI

Terminales



Electricos

DIBUJADO	V.Roura	04/06/09
CONTROL	F.Adamuz	04/06/09
ESCALA	5/1	

**NORMAS
MATERIALES**
EN1654*

**NORMAS
DIMENSIONALES**
Especiales

**TOLERANCIAS
GENERALES**
±0.2 ±2°

FORMATO A4

NOMBRE PT7532 "c"

REF. 7532.xx