

Secc.X

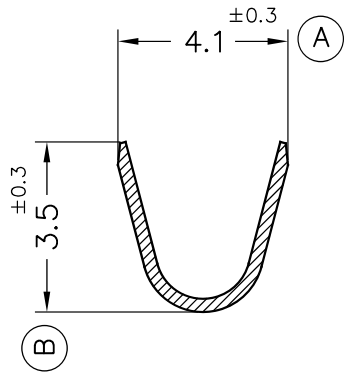

Secc.Y

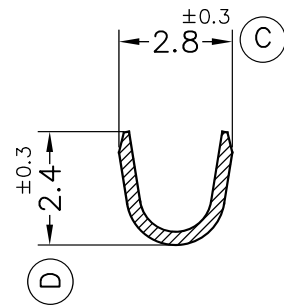

Secc.Z-Z

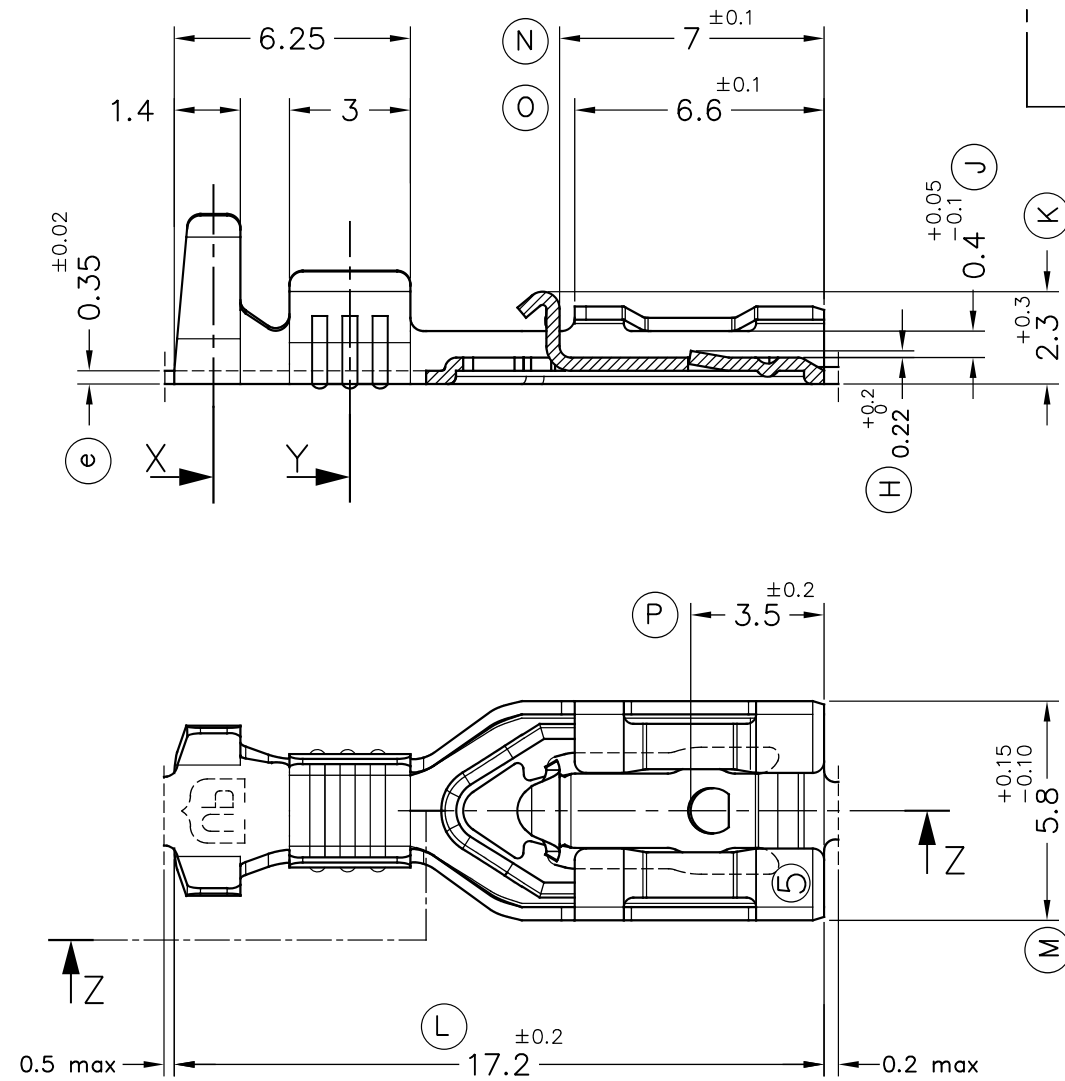

FORMA DE SUMINISTRO

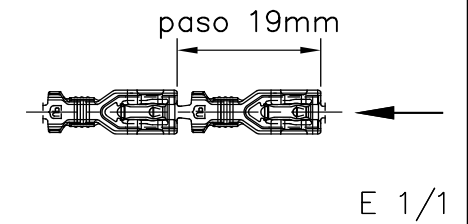

MACHO DE CONEXIÓN SUGERIDO/SUGGESTED MALE

- Material CuZn o Fe-Pre Ni
- Sin rebabas en el agujero/No burrs at hole
- Planitud dentro de 0.03mm en toda su longitud/ Flatness within 0.03mm over the whole length
- Agujero simétrico sobre el eje del macho/ Hole be symmetrical about tab acc. drawing specification

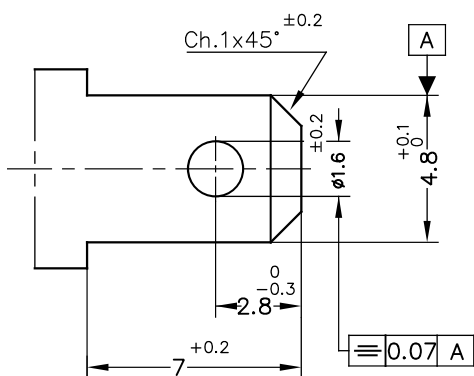
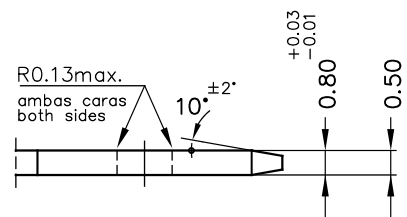

E 5:1

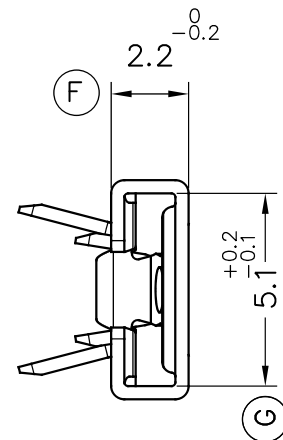

4768.51	Pre-Sn	CuNiSi*	0.2±0.6mm ²	1.1±2.1mm.	4.8x0.5	01 _{vr}	Tol.cota H/ 5	01/06/16
4768.24	Pre-Niq.	Acero						
4768.01	Pre-Sn	Latón*						
4768.00	Natural	CuZn30						
Referencias	Acabados	Material	Sección Conductor	φ Aislante	Para Macho	Rev.	Modificación	Fecha



TERMINAL HEMBRA Serie 4.8
UP-TPSEK3



DIBUJADO	EP	21/01/16
CONTROL	XM	15/03/16
ESCALA	5/1	

NORMAS MATERIALES	NORMAS DIMENSIONALES	TOLERANCIAS GENERALES
EN 1654 *	Especiales	±0.2 ±2°

FORMATO	A3h
NOMBRE	PT4768 "c"
REF.	4768.xx