

SECT. Z-Z'

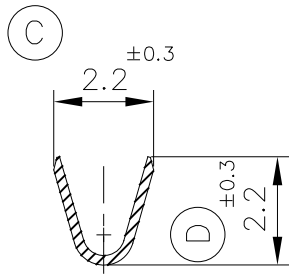

SECT. X-X'

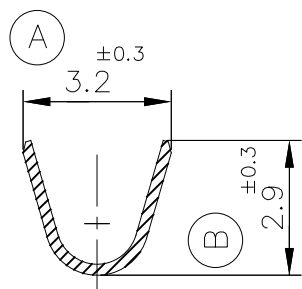

DELIVERED FORM: ON REELS

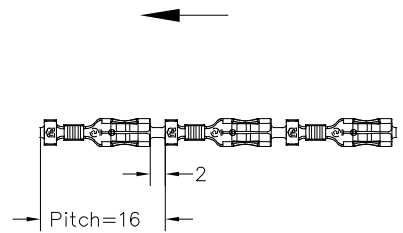

ESC. 1:1

Detalle A
Esc: 10/1

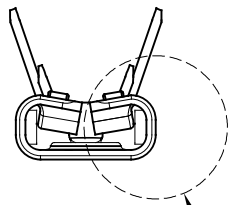
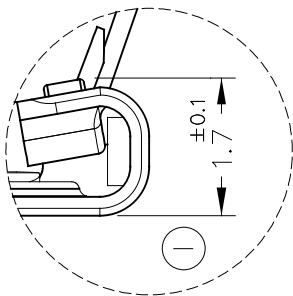

Detalle A

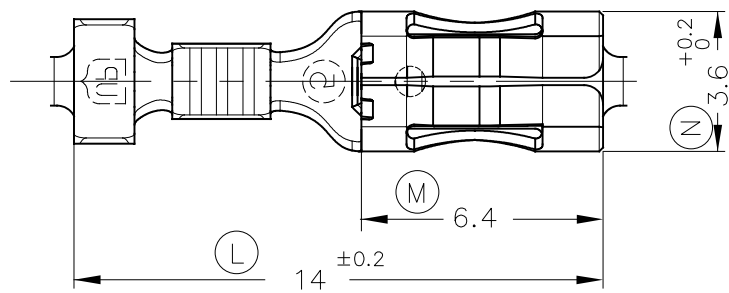
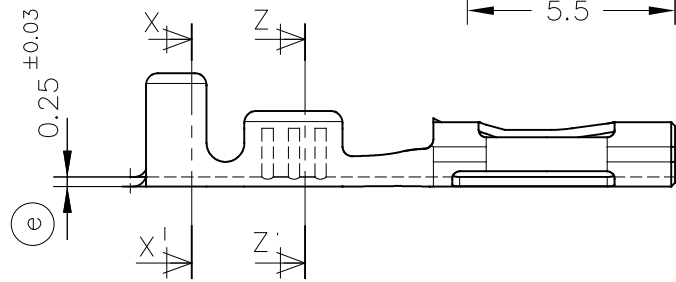
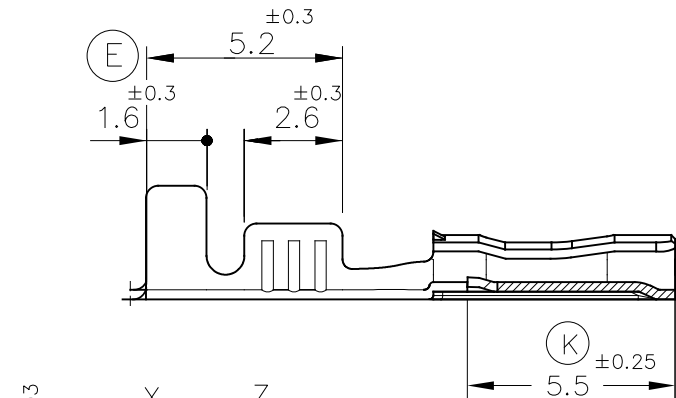

| | | | | | | | | | | | | |
|------------|----------------|-----------------|------------------------|--------------|---------|---|---|---|---|------|--------------|----------|
| 4601.01 | Pre Tinplated | Brass CuZn30 | 0.2-0.6mm ² | 1.5+2mm. | 2.8x0.5 | | | | | 01 | Mod. Section | 24/09/19 |
| 4601.00 | Unplated | | | | | | | | | 00 | 1st. Edition | 28/06/19 |
| References | Surface Treat. | Material | Section | ∅ Insulation | For tab | A | B | C | D | Rev. | Modificación | Fecha |

| | | | | | | | | | | |
|---|----------|----------|---|----------------------------------|-----------------------------------|--------|--|------------|--|--|
| <p>ESPECIALTATS ELÈCTRIQUES ESCUBEDO S.A.U.</p> | | | <p>LOW INSERTION RECEPTACLE SERIES 2,8mm.</p> | | | | | | | |
| DESIGN | M.Codina | 28/06/19 | MATERIAL STANDARD EN 1654 | DIMENSION STANDARD Special | GENERAL TOLERANCES ±0.2 ±2° | FORMAT | | A4v | | |
| VERIFY | X.Menac | 28/06/19 | | | | FILE | | PT4601 "c" | | |
| SCALE | 5/1 | | | | | REF. | | 4601.xx | | |