

FORMA DE SUMINISTRO

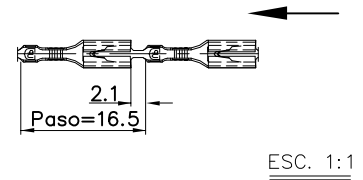

Secc. Y-Y'

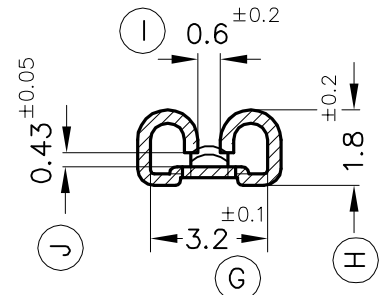

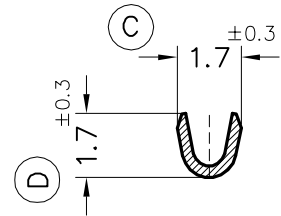

Secc. Z-Z'

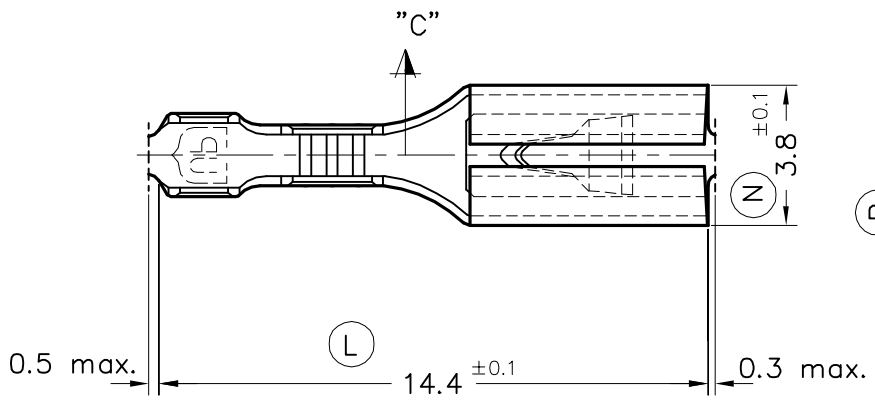
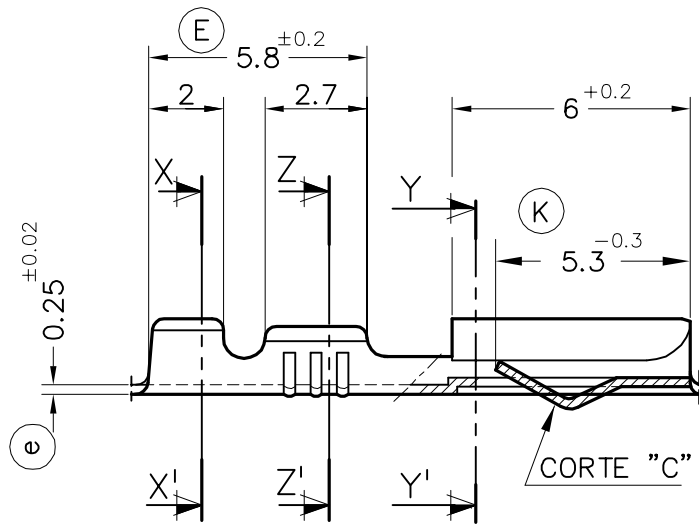
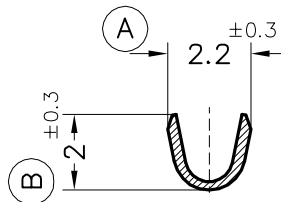

Secc. X-X'



4503.32	Estañado	Bronce*	0.1 ÷ 0.3 mm ²	1 ÷ 1.8 mm.	2.8x0.5						02	Geo. Retención	17/10/11
4503.30	Natural	CuSn6									01	Mdf. cota (H)	27/04/06
4503.02	Estañado	Latón*									00	1ª Edición	19/04/06
4503.00	Natural	CuZn30									Rev.	Modificación	Fecha

 ESCUBEDO Especialitats Elèctriques Escubedo S.A.			TERMINAL HEMBRA Serie 2.8					Terminales  Electricos	
DIBUJADO	V.Roura	13/03/06	NORMAS MATERIALES EN1654*	NORMAS DIMENSIONALES Especiales	TOLERANCIAS GENERALES ±0.2 ±2°	FORMATO	A4v		
CONTROL	F.Adamuz	13/03/06				NOMBRE	PT4503 "c"		
ESCALA	5/1		REF.		4503.xx				