

Secc. Z-Z^I

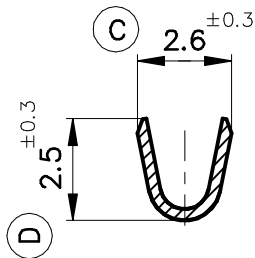

Secc. X-X^I

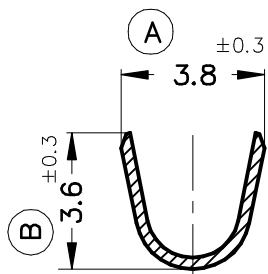

FORMA DE SUMINISTRO

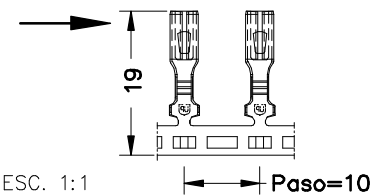

Secc. Y-Y^I

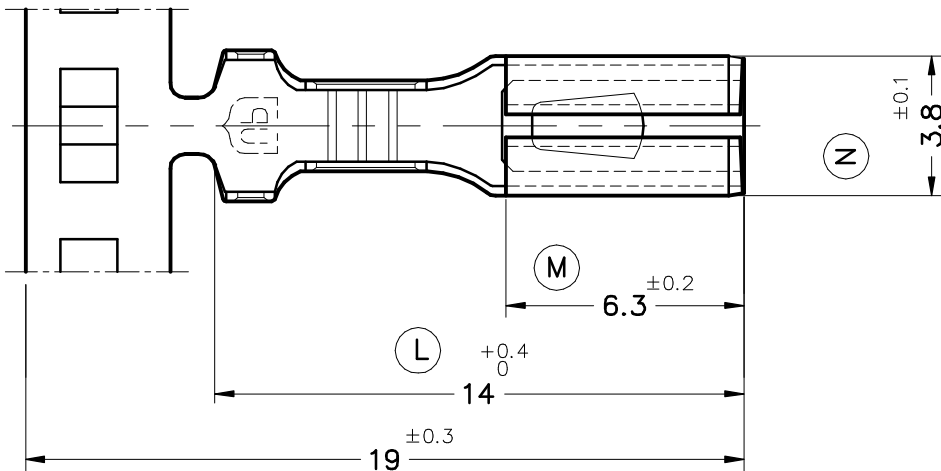
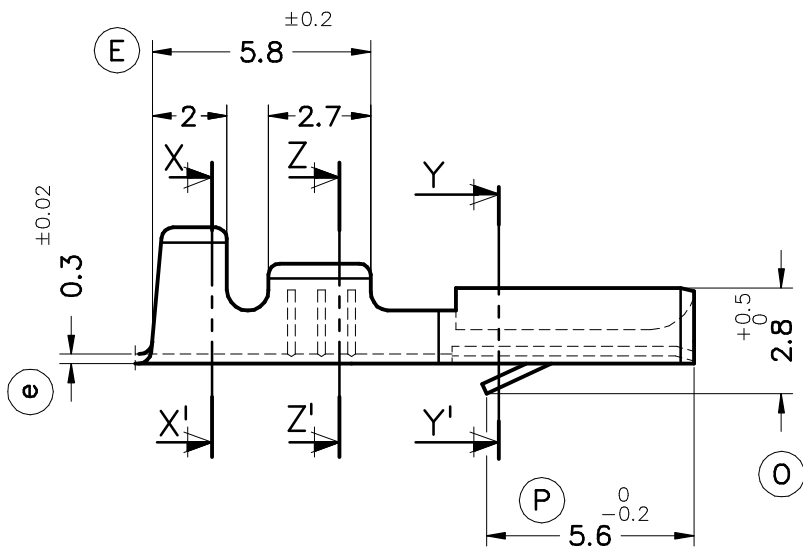
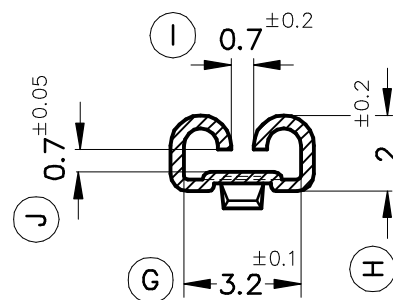

4108.31	Pre-estañado	Bronce*	0.5÷1mm. ²	1.8÷2.5mm.	2.8x0.8								
4108.30	Natural	CuSn6											
4108.01	Pre-estañado	Latón*								01	Actualizar plano	15/02/06	
4108.00	Natural	CuZn30								00	1ª Edición	14/07/05	
Referencias	Acabados	Material	Sección Conductor	∅ Aislante	Para Macho	A	B	C	D	Rev.	Modificación	Fecha	



ESCUBEDO
Especialitats Elèctriques Escubedo S.A.

TERMINAL HEMBRA PARA CONECTOR Serie 2.8

Terminales Electricos

DIBUJADO	V. Roura	12/05/05
CONTROL	F. Adamuz	12/05/05
ESCALA	5/1	

NORMAS MATERIALES	NORMAS DIMENSIONALES	TOLERANCIAS GENERALES
EN 1654*	Din 46340	±0.2 ±2°

FORMATO	A4v
NOMBRE	PT4108 "c"
REF.	4108.xx