

## 5876.\*\*

### 5 (.197) TYPE SERIES TERMINALS - LOW INSERTION



**Description** Flag receptacle for 5 x 0.8 Tabs.

**Wire section range** 0.50 ÷ 1.50 mm<sup>2</sup> (AWG 20 ÷ 16)

**Max. Insulator Ø** 3.3 mm



**Materials,  
Temperature &  
Contact resistance**

Part nr.	Material	Finish	Max. temp. (C°)	Resist. (mΩ)
5876.00	Brass	Natural	110	(T.B.D.)
5876.01	Brass	Pre tin plated	120	(T.B.D.)
5876.02	Brass	Tin plated	120	(T.B.D.)
5722.30	Bronze	Natural	120	(T.B.D.)
5876.31	Bronze	Pre tin plated	130	(T.B.D.)
5876.32	Bronze	Tin plated	130	(T.B.D.)

**Notes:** Maximal contact resistance: only contact area

**Material thickness** 0.35 mm

**Max. Rated current**

**Maximum Current values.**

Values of the table show the recommended maximum current values, limited by the cross section of the cable used.

These maximum values also depend on the ambient temperature, and can be reduced depending on the working conditions.

For more precise information about the maximum rating current applicable in each case, consult the "Temperature Rise" and "De-rating" curves.

Wire section (mm <sup>2</sup> )	Current (A)
0.50	8
0.75	10
1.00	12
1.50	16

**Insertion/Withdrawal forces**

1 <sup>st</sup> . Insertion	35 N Max.
1 <sup>st</sup> . Withdrawal	60 N Max.
6 <sup>th</sup> . Withdrawal	18 N Min.

**Application tool** MN5872

**Wire striping length** 4.0 (±0.5) mm

**Crimping parameters &  
Pull out force**

Wire section (mm <sup>2</sup> ±10%)		Conductor (mm)		Insulator (mm)	Pull-out force (N)
Nominal	Actual	Height (±0,05)	Width (measured)	Width (measured)	Escubedo
0.50	0.45	1.25	2.42	3.50	>85
0.75	0.71	1.35	2.44	3.50	>130
1.00	0.93	1.45	2.45	3.50	>170
1.50	1.45	1.65	2.49	3.50	>220

**Note:** Values only valid for the application tool specified. The insulator width is only indicative as they depend of the insulation properties.

**Packaging** 5000 Pieces on 20 mm. cardboard reel, 15.5 mm terminal chain pitch

**5876.\*\***

**5 (.197) TYPE SERIES TERMINALS - LOW INSERTION**



**Drawing**

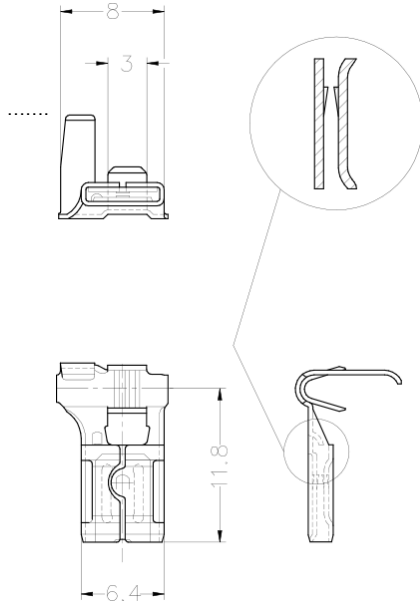

**Approvals**

- RoHS Compliant



**Connectors Compatibility**

Reference	Color	Nº Ways	PA66V2	PA66V0	No Flame
2483410	Natural	1	x		

**Note:** For others materials and colours consult: [info@escubedo.com](mailto:info@escubedo.com)

Note: (T.B.D.) to be determined

**Disclaimer**

Data obtained from Escubedo Laboratory essays, using own methodology, cablings, equipment and original crimping tools, done in laboratory conditions and following the indicated standards, errors and omissions excepted. This document has no contractual meaning and it is publicised only for informative purposes. It can be changed without prior notice. The end customer has the sole responsibility to check these characteristics in its environment and with its own components, manufacturing methods and equipment. See also the full range product overview if available. For further information please visit our web site or contact us.

Rev. Nr.	Concept	Date	Created/Revised	Approved
5	Update	05/21/2016	D.Martinez / E.Roura	J.C.Sanchez
4	Standard max. Temp. change	10/03/2011	D.Martinez	J.C.Sanchez