



5734S**

6.3 (.250) TYPE SERIES · FLAGS

SELF-LOCKING RECEPTACLES. LOW INSERTION TERMINALS.



Specification Extra low insertion

For male (mm) 6,3x0,8

Wire size mm² (AWG) 2,5-4 (14-12)

Materials, temperature and contact resistance

Part nr.	Material	Finishing	Max. Temp. (°C)
5734S00	Brass	Natural	110
5734S01	Brass	Pre-tin-plated	120

Material thickness (mm) 0,4

Insertion / Withdrawal forces

	5734S00 / 01
1st Insertion (max)	15N ¹
1st Withdrawal (max)	20N ¹
1st Withdrawal (min, locking enabled)	60N ¹

¹ Valid for Natural Brass Tab

Security function

Self-locking function prevents disconnection by pulling the cable. Disconnection is possible disabling the locking function, pressing the lever manually or sliding the connector (see withdrawal forces). It allows several connections-disconnections maintaining the functional features.

Winding number 3000

Compatible connectors 26433**

Approvals



Drawing

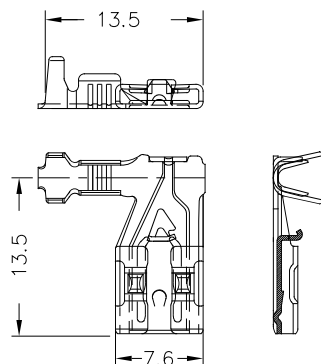

Disclaimer

Data obtained from Escubedo Laboratory essays, using own methodology, cabling, equipment and original crimping tools, done in laboratory conditions and following the indicated standards, errors and omissions excepted. This document has no contractual meaning and it is publicised only for informative purposes. It can be changed without prior notice. The end customer has the sole responsibility to check these characteristics in its environment and with its own components, manufacturing methods and equipment. See also the full range product overview if available. For further information please visit our web site or contact us

Rev. Nr.	Concept	Date	Created/Revised	Approved
A1	Datasheet generated automatically [A1]	2018-09-19	Laboratory Dept.	E. Roura