

4904.** 2.8 (.110) TYPE SERIES · RECEPTACLES SELF-LOCKING RECEPTACLES. LOW INSERTION TERMINALS.



Specification Low insertion

For male (mm) 2,8x0,5

Wire size mm² (AWG) 0,2-0,6 (24-20)

Materials, temperature and contact resistance

Part nr.	Material	Finishing	Max. Temp. (°C)	Contact Resist (mΩ)
4904.00	Brass	Natural	110	1.75
4904.01	Brass	Pre-tin-plated	120	1.25
4904.24	Steel	Nickel-plated	300	2.50

Material thickness (mm) 0,3

Max. rated current

Wire section	4904.00 / 01 / 24
0.25 mm ²	2A
0.35 mm ²	3A
0.50 mm ²	6A

Insertion / Withdrawal forces

	4904.00 / 01 / 24
1st Insertion (max)	20N ¹
1st Withdrawal (max)	20N ¹
1st Withdrawal (min, locking enabled)	50N ¹

¹ Valid for Natural Brass Tab

Security function

Self-locking function prevents disconnection by pulling the cable. Disconnection is possible disabling the locking function, pressing the lever manually or sliding the connector (see withdrawal forces). It allows several connections-disconnections maintaining the functional features.

Application tool

MN4905

Crimping parameters & pull out force

Wire section (±10%)	Conductor		Insulator	Pull-out force (N)
	Height (mm)	Width (mm)	Width (mm)	
0.25 mm ²	0.97 (±0.03)	1.76 (±0.03)	2.47 (±0.10)	28N @ 60s
0.35 mm ²	1.00 (±0.03)	1.75 (±0.03)	2.47 (±0.10)	40N @ 60s
0.50 mm ²	1.05 (±0.03)	1.75 (±0.03)	2.49 (±0.10)	56N @ 60s
20 AWG	1.05 (±0.03)	1.76 (±0.03)	2.51 (±0.10)	58N @ 60s
22 AWG	1.00 (±0.03)	1.76 (±0.03)	2.48 (±0.10)	36N @ 60s
24 AWG	0.95 (±0.03)	1.75 (±0.03)	2.47 (±0.10)	22.3N @ 60s

Values only valid for the application tool specified upwards. The insulator widths are only indicative as they are dependent on the sheath thickness of the wire used.

Winding number 15000

Compatible connectors 22817**

Approvals



4904.**

2.8 (.110) TYPE SERIES · RECEPTACLES

SELF-LOCKING RECEPTACLES. LOW INSERTION TERMINALS.

Up TP SEK3

Drawing

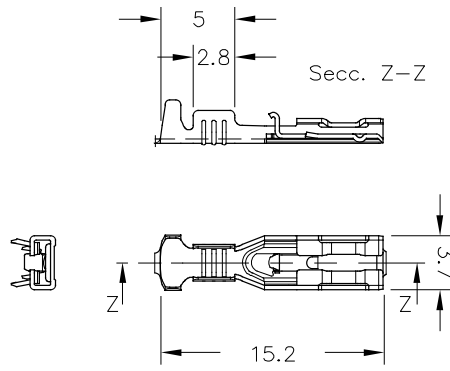

4904.00 NATURAL BRASS



2.8 (.110) TYPE SERIES · RECEPTACLES
SELF-LOCKING RECEPTACLES. LOW INSERTION TERMINALS.

Derating curve Current carrying capacity vs. Ambient temperature

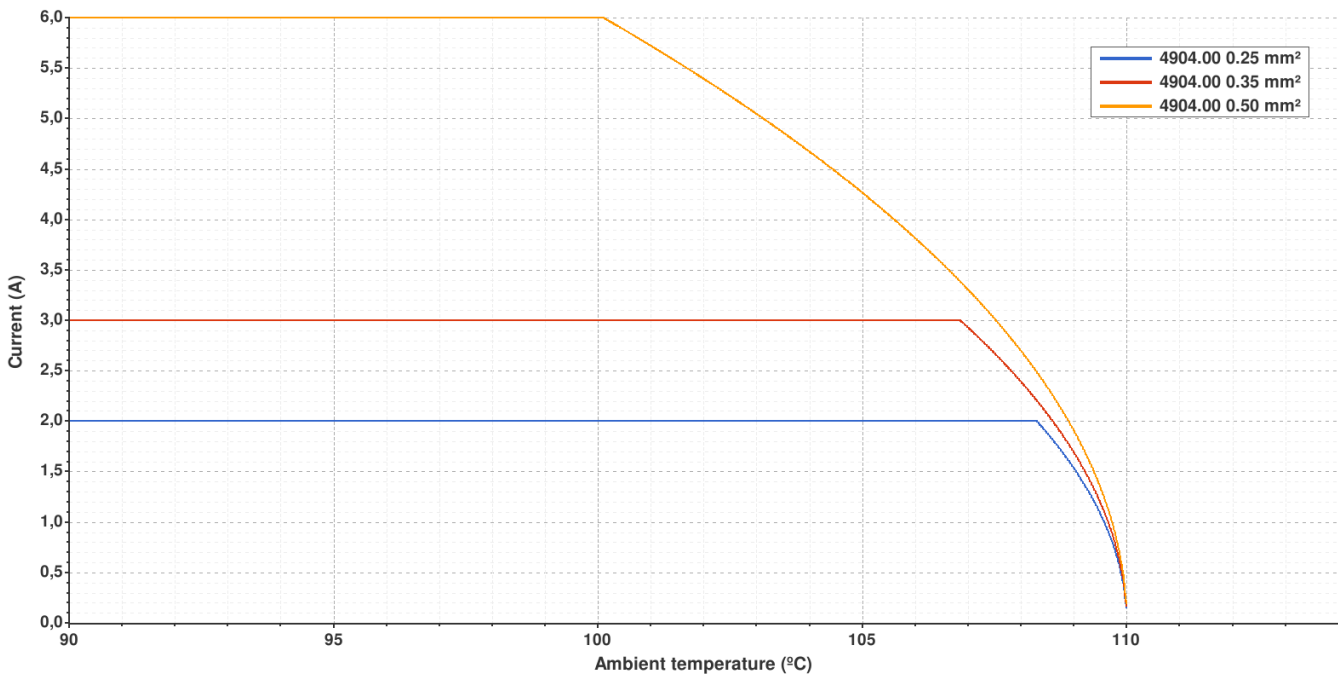

Temperature rise curve Terminal temperature rise due to the current carried

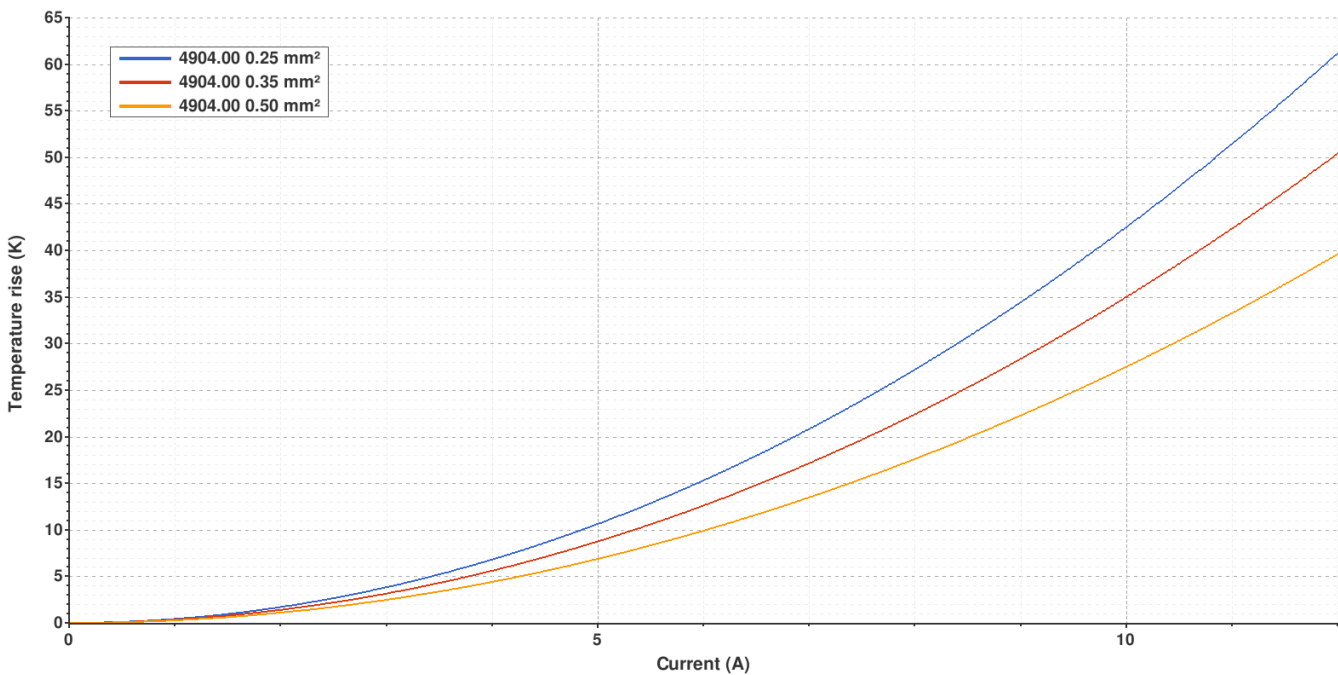

Valid for Natural brass tab

4904.01 PRE-TIN-PLATED BRASS



2.8 (.110) TYPE SERIES · RECEPTACLES
SELF-LOCKING RECEPTACLES. LOW INSERTION TERMINALS.

Derating curve Current carrying capacity vs. Ambient temperature

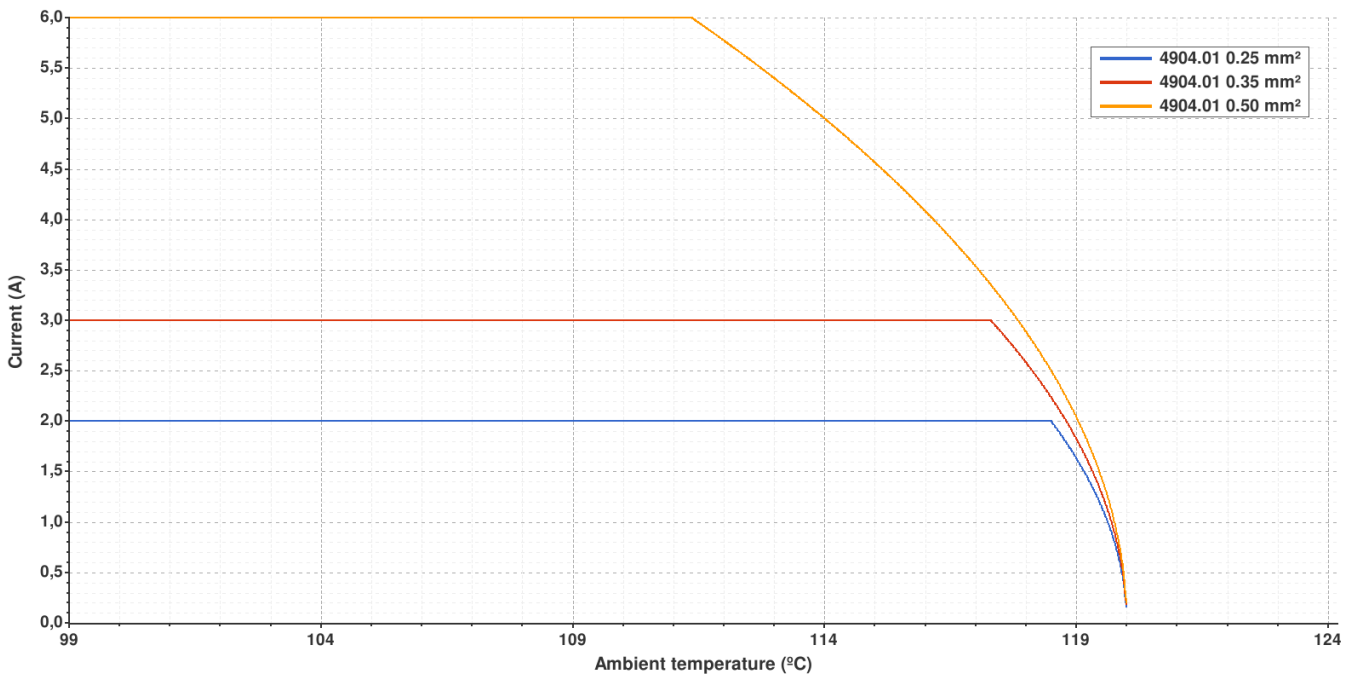

Temperature rise curve Terminal temperature rise due to the current carried

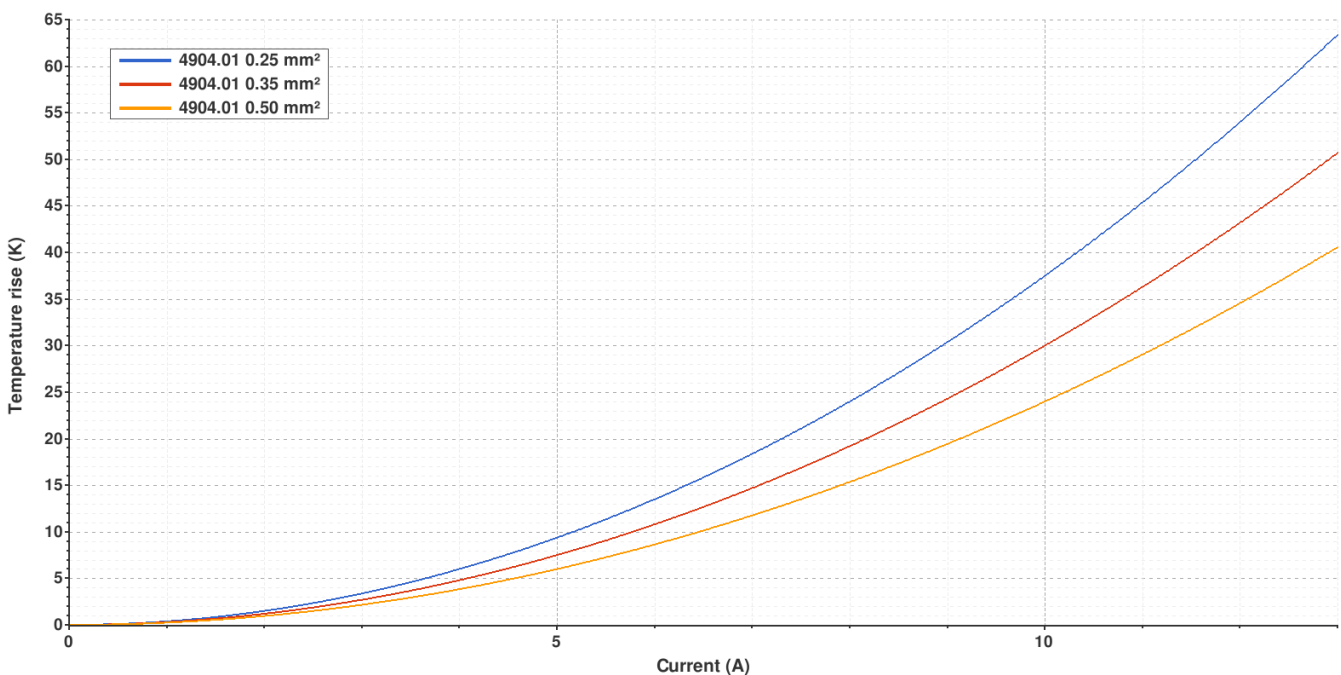

Valid for Natural brass tab

4904.24 NICKEL-PLATED STEEL



2.8 (.110) TYPE SERIES · RECEPTACLES
SELF-LOCKING RECEPTACLES. LOW INSERTION TERMINALS.

Derating curve Current carrying capacity vs. Ambient temperature

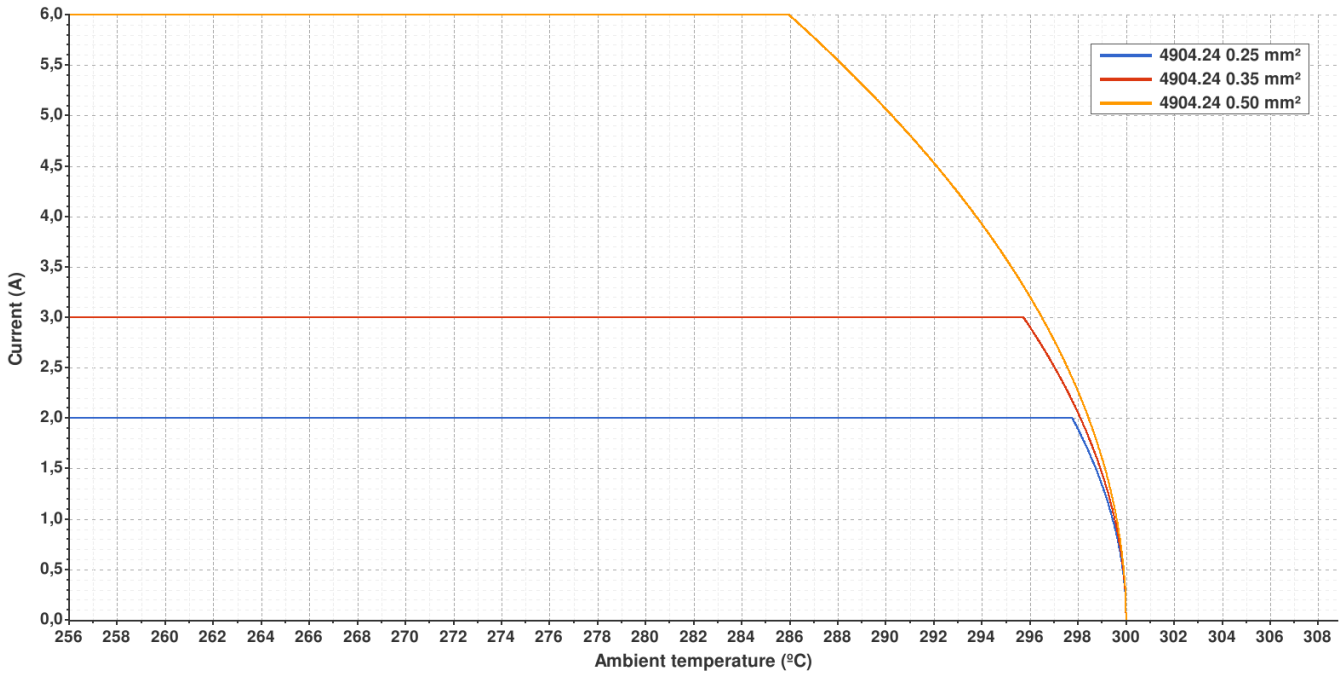

Temperature rise curve Terminal temperature rise due to the current carried

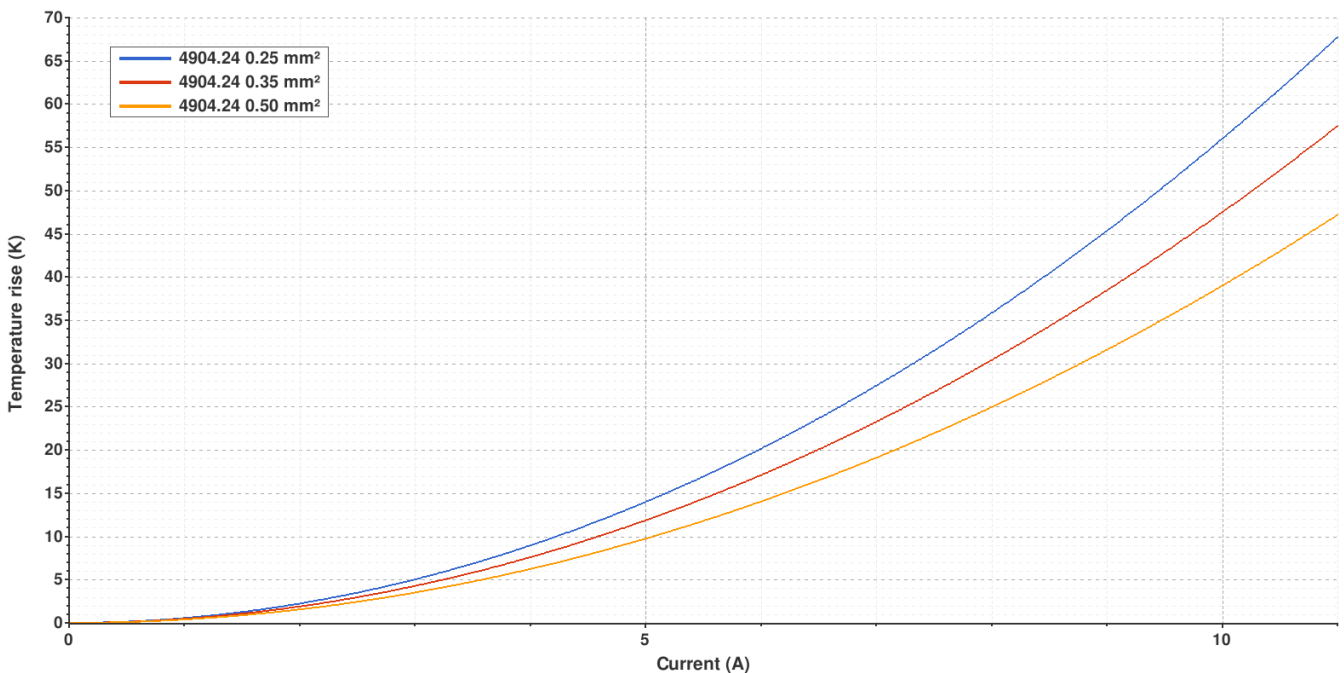

Valid for Natural brass tab

4904.****2.8 (.110) TYPE SERIES · RECEPTACLES****SELF-LOCKING RECEPTACLES. LOW INSERTION TERMINALS.****Disclaimer**

Data obtained from Escubedo Laboratory essays, using own methodology, cablings, equipment and original crimping tools, done in laboratory conditions and following the indicated standards, errors and omissions excepted. This document has no contractual meaning and it is publicised only for informative purposes. It can be changed without prior notice. The end customer has the sole responsibility to check these characteristics in its environment and with its own components, manufacturing methods and equipment. See also the full range product overview if available. For further information please visit our web site or contact us

Rev. Nr.	Concept	Date	Created/Revised	Approved
A4	Change company name and logo	2021-10-21	Laboratory Dept.	E. Roura
A3	Correction - Subtitle of the datasheet	2019-03-21	Laboratory Dept.	E. Roura
A2	Upadate datasheet. De-rating, temperature rise and contact resistance	2019-01-31	Laboratory Dept.	E. Roura
A1	Datasheet generated automatically [A1]	2018-09-17	Laboratory Dept.	E. Roura