



4776.**

4.8 (.187) TYPE SERIES · RECEPTACLES

SELF-LOCKING RECEPTACLES. LOW INSERTION TERMINALS.



Specification Self-locking terminals under TP design

For male (mm) 4,8x0,8

Wire size mm² (AWG) 1-2,5 (18-14)

Ø Insulation (mm) 3-4,3

Materials, temperature and contact resistance

Part nr.	Material	Finishing	Max. Temp. (°C)	Contact Resist (mΩ)
4776.00	Brass	Natural	110	1.50
4776.01	Brass	Pre-tin-plated	120	1.25
4776.24	Steel	Nickel-plated	300	2.50
4776.51	Cu. Alloy	Pre-tin-plated	150	0.75

Material thickness (mm) 0,35

Max. rated current

Wire section	4776.00 / 01 / 24 / 51
1.00 mm ²	12A
1.50 mm ²	16A
2.00 mm ²	16A
2.50 mm ²	20A

Insertion / Withdrawal forces

	4776.00 / 01 / 24 / 51
1st Insertion (max)	25N ¹
1st Withdrawal (max)	25N ¹
1st Withdrawal (min, locking enabled)	70N ¹

¹ Valid for Natural Brass Tab

Security function

Self-locking function prevents disconnection by pulling the cable.
Disconnection is possible disabling the locking function, pressing the lever manually or sliding the connector (see withdrawal forces).
It allows several connections-disconnections maintaining the functional features.

Application tool MN4772

Wire strip length 4.5 (±0.5) mm

Crimping parameters & pull out force

Wire section (±10%)	Conductor 		Insulator	Pull-out force (N)
	Height (mm)	Width (mm)		
1.00 mm ²	1.50 (±0.05)	2.68 (±0.05)	3.65 (±0.10)	108N @ 60s
1.50 mm ²	1.65 (±0.05)	2.68 (±0.05)	3.66 (±0.10)	150N @ 60s
2.00 mm ²	1.80 (±0.05)	2.70 (±0.05)	3.68 (±0.10)	150N @ 60s
2.50 mm ²	1.95 (±0.05)	2.72 (±0.05)	3.69 (±0.10)	230N @ 60s
14 AWG	1.90	2.70	(T.B.D.)	223N @ 60s
16 AWG	1.65	2.68	(T.B.D.)	133N @ 60s
18 AWG	1.50	2.68	(T.B.D.)	89N @ 60s

Values only valid for the application tool specified upwards. The insulator widths are only indicative as they are dependent on the sheath thickness of the wire used.

Winding number 6000

Compatible connectors 24817**



4776.**

4.8 (.187) TYPE SERIES · RECEPTACLES

SELF-LOCKING RECEPTACLES. LOW INSERTION TERMINALS.



Approved regulations

Part nr.	Approval	Standard	File	Certified framework
4776.00	UL	UL 310	E211727	AWG 18-14 (16-41 Stranded Cu) / MN4772 or MN4776
4776.01	UL	UL 310	E211727	AWG 18-14 (16-41 Stranded Cu) / MN4772 or MN4776
4776.24	UL	UL 310	E211727	AWG 18-14 (16-41 Stranded Cu) / MN4772 or MN4776

Approvals



Drawing

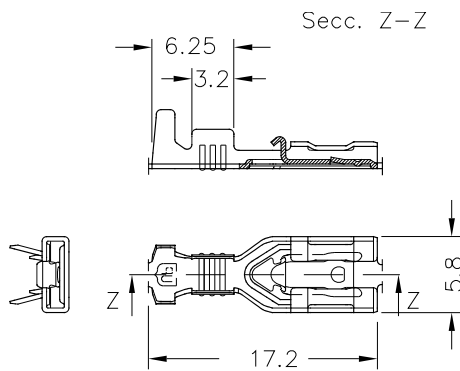



4776.00 NATURAL BRASS

4.8 (.187) TYPE SERIES · RECEPTACLES
SELF-LOCKING RECEPTACLES. LOW INSERTION TERMINALS.



Derating curve

Current carrying capacity vs. Ambient temperature

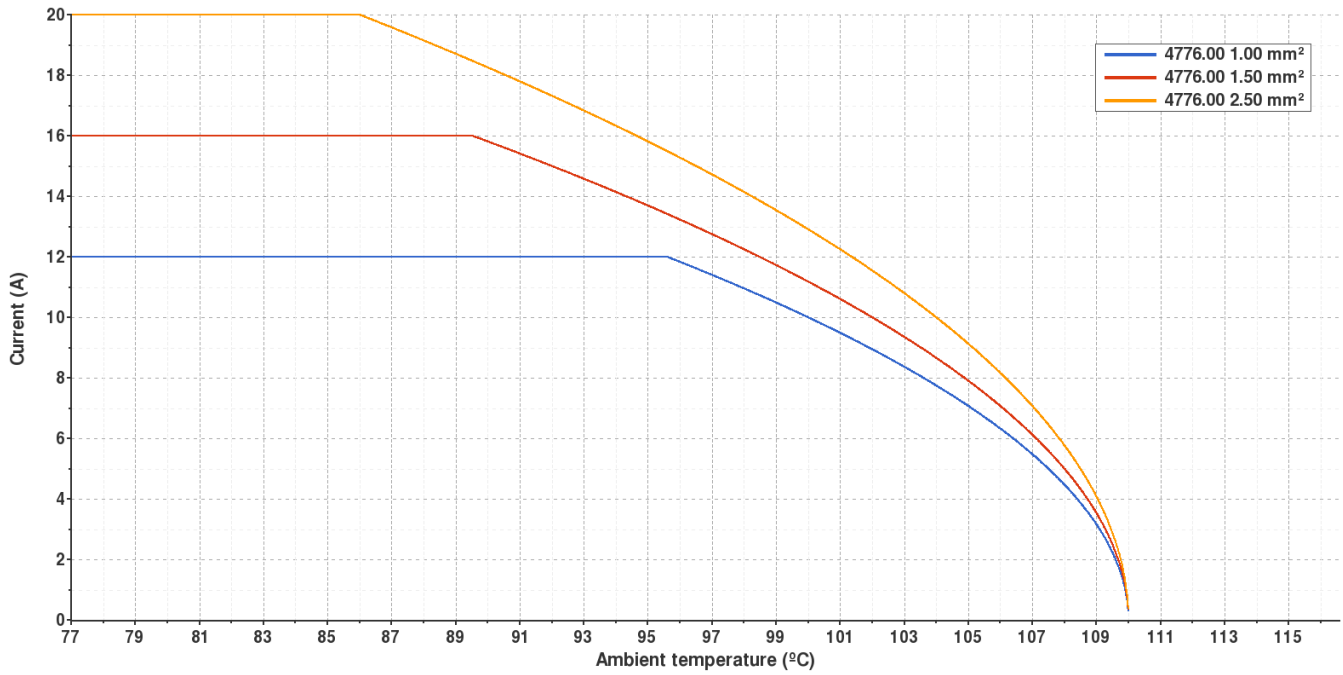

Temperature rise curve

Terminal temperature rise due to the current carried

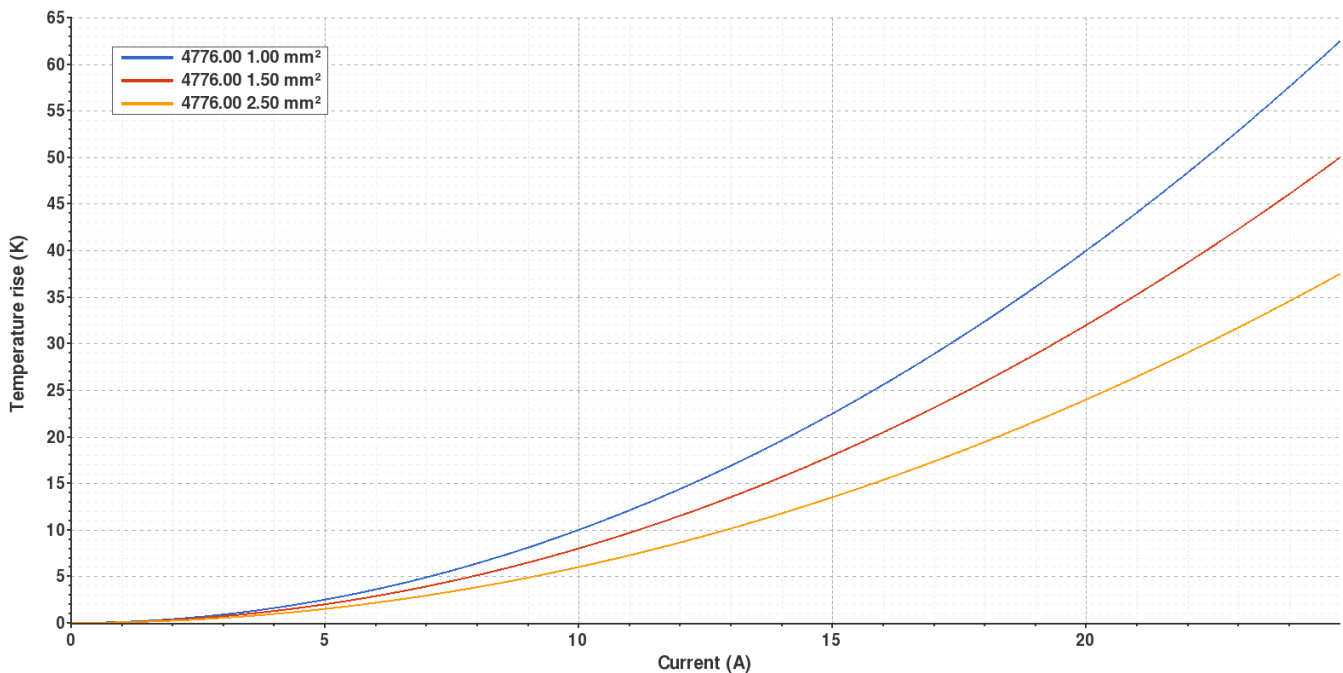

Valid for Natural Brass Tab



4776.01 PRE-TIN-PLATED BRASS

4.8 (.187) TYPE SERIES · RECEPTACLES
SELF-LOCKING RECEPTACLES. LOW INSERTION TERMINALS.



Derating curve Current carrying capacity vs. Ambient temperature

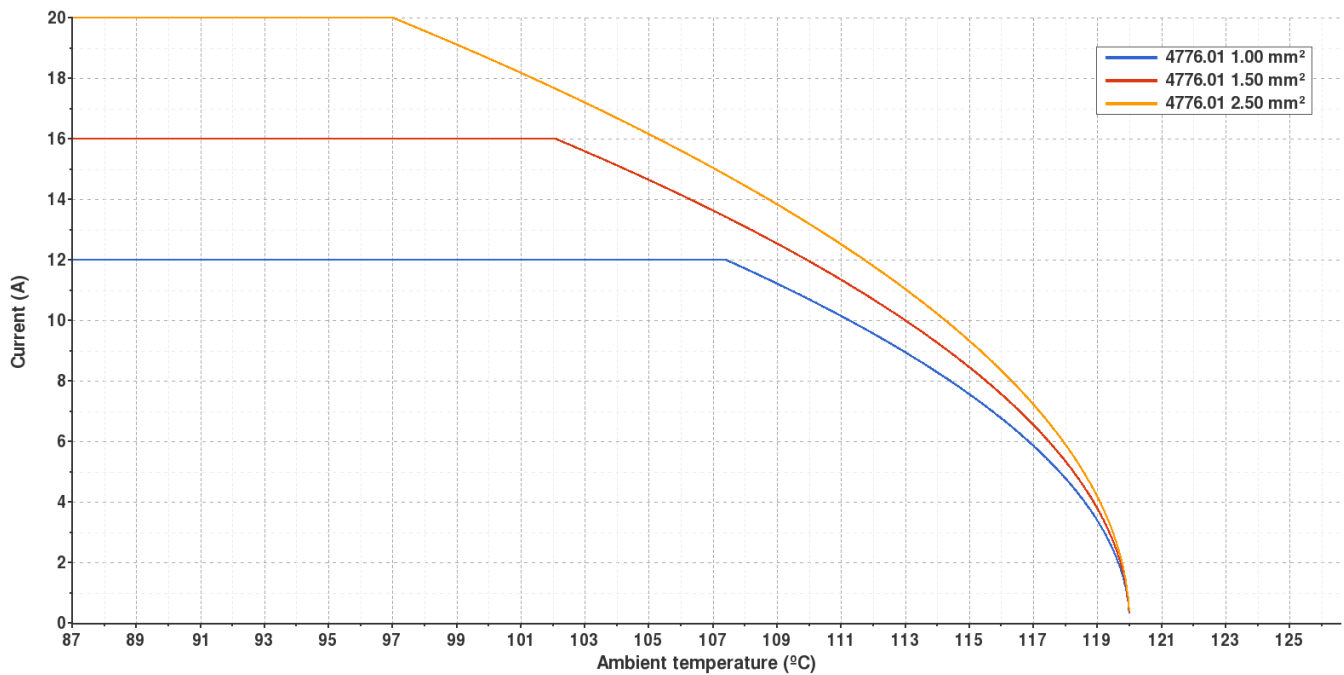

Temperature rise curve Terminal temperature rise due to the current carried

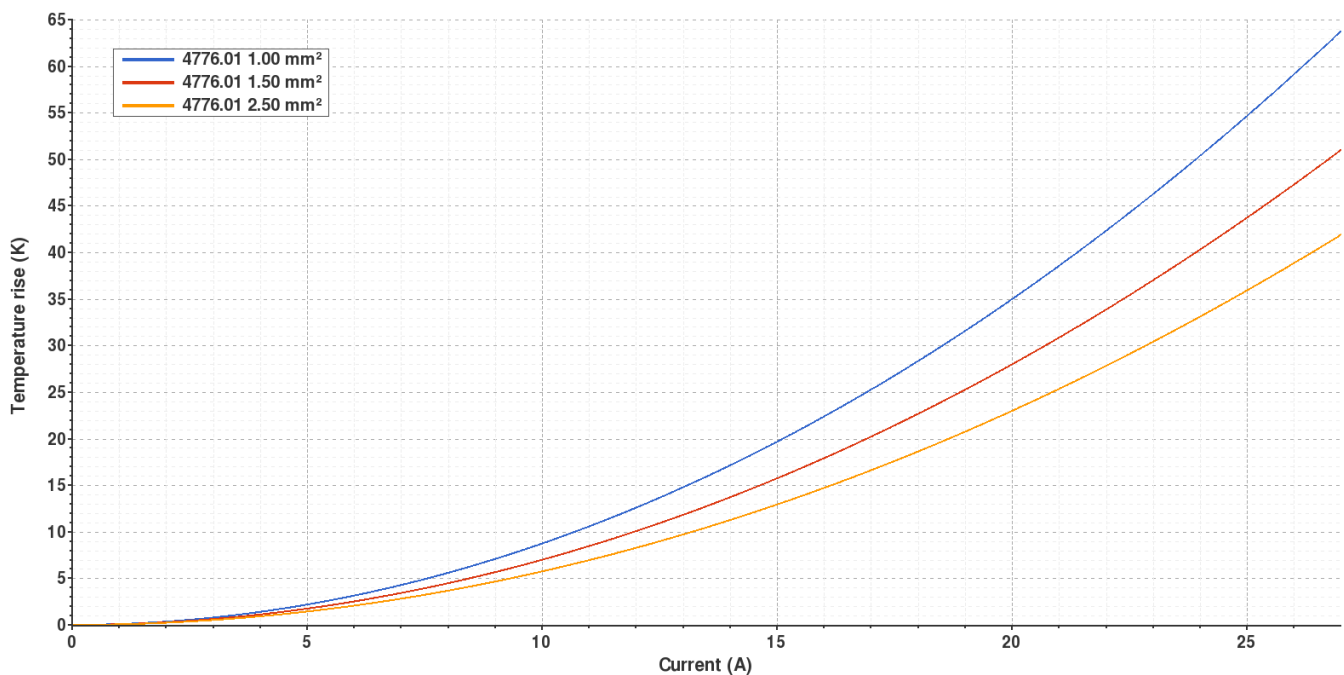

Valid for Natural Brass Tab



4776.24 NICKEL-PLATED STEEL



4.8 (.187) TYPE SERIES · RECEPTACLES
SELF-LOCKING RECEPTACLES. LOW INSERTION TERMINALS.

Derating curve

Current carrying capacity vs. Ambient temperature

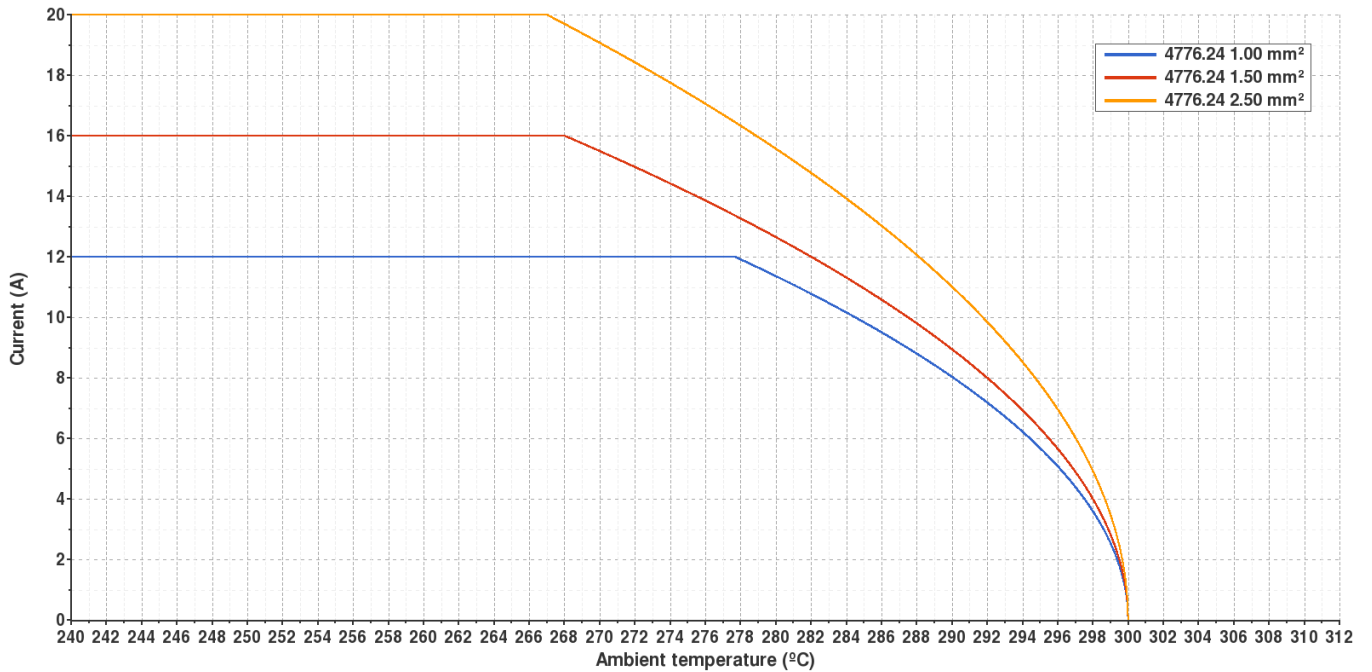

Temperature rise curve

Terminal temperature rise due to the current carried

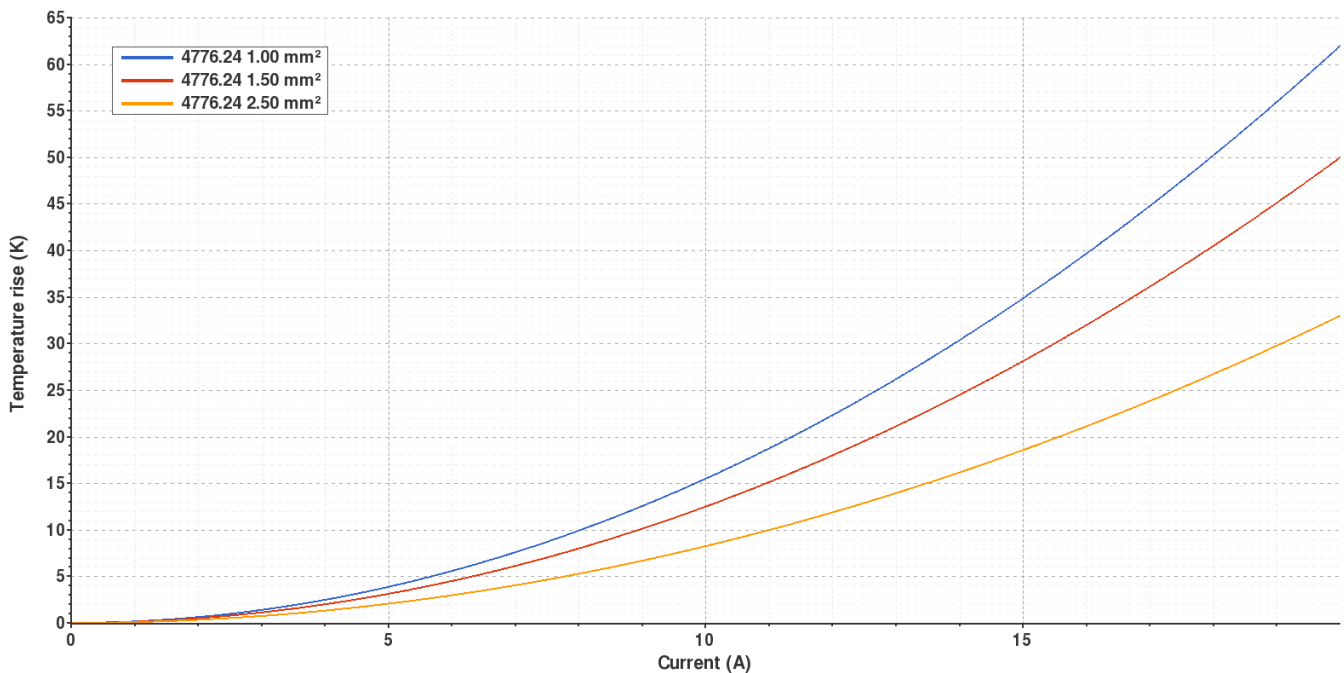

Valid for Natural Brass Tab



4776.**

4.8 (.187) TYPE SERIES · RECEPTACLES

SELF-LOCKING RECEPTACLES. LOW INSERTION TERMINALS.



(T.B.D.): To be determined

Disclaimer

Data obtained from Escubedo Laboratory essays, using own methodology, cablings, equipment and original crimping tools, done in laboratory conditions and following the indicated standards, errors and omissions excepted. This document has no contractual meaning and it is publicised only for informative purposes. It can be changed without prior notice. The end customer has the sole responsibility to check these characteristics in its environment and with its own components, manufacturing methods and equipment. See also the full range product overview if available. For further information please visit our web site or contact us

Rev. Nr.	Concept	Date	Created/Revised	Approved
A3	Correction - Subtitle of the datasheet	2019-03-21	Laboratory Dept.	E. Roura
A2	Update de-rating curve	2018-11-27	Laboratory Dept.	E. Roura
A1	Datasheet generated automatically [A1]	2018-09-19	Laboratory Dept.	E. Roura